

REV.	ECN. #	DESCRIPTION	NAME	DATE
A0		NEW RELEASE	S. H. Peng	03/20/25

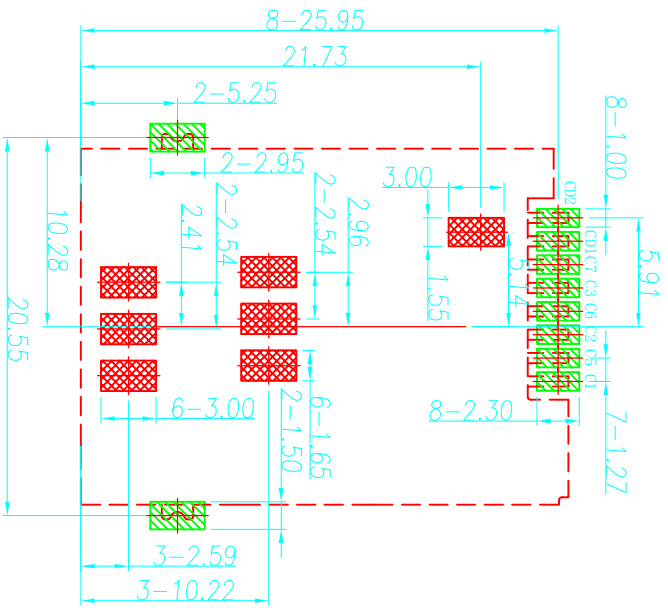
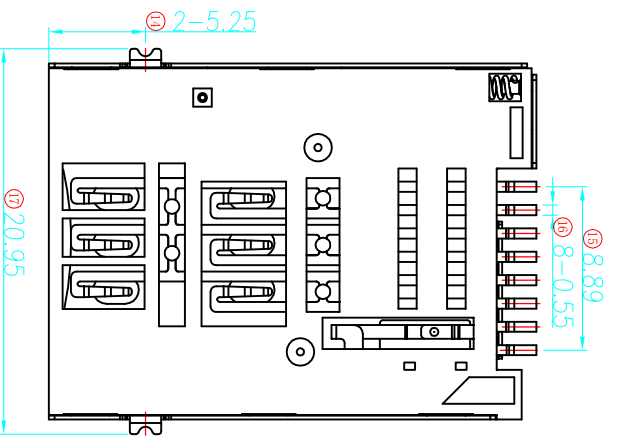
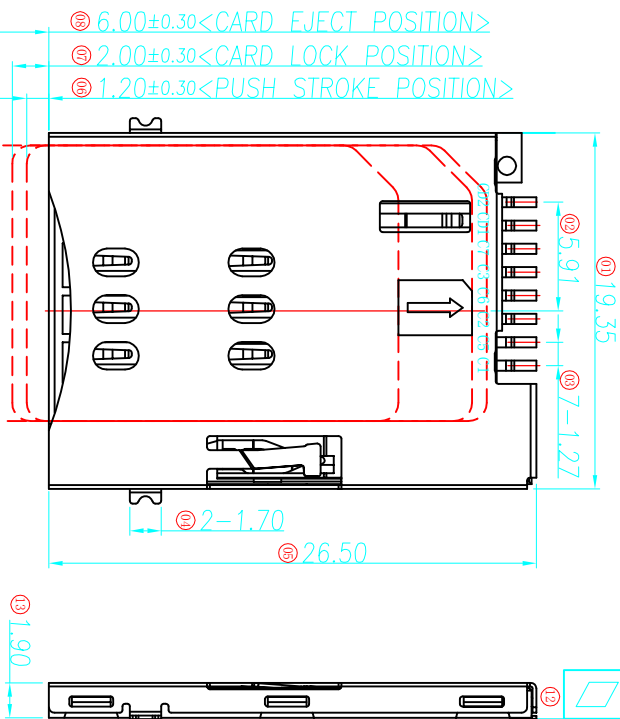

**RECOMMENDED PCB LAYOUT**

**TOLERANCE: ±0.05**

- SMT SOLDER AREA
- COPPER RESTRICTED AREA
- 1. TOUCH AREA OF CONTACT
- TIPS NO ELECTRICAL FUNCTION
- 2. NO FIRST PCB LAYOUT
- CIRCUITS IN THE AREA

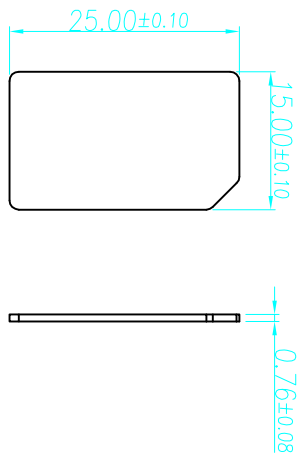

Notes:  
 1. Material:  
 Housing: High Temperature Thermoplastic  
 Terminal: Copper Alloy  
 Shell: Stainless Steel  
 2. Plating:  
 Terminal: 50u" Ni Underplated Overall  
 G/F Plated on Contact Area  
 Matte Tin Plated on Solder Area  
 Shell: 30u" Ni Underplated Overall  
 3. Technical Speciality:  
 Rated Voltage: 30V  
 Current Rating: 0.5A  
 Insulation Resistance: 1000MΩ Min.  
 Contact Resistance: 100mΩ Max.  
 Withstanding Voltage: 500V DC For 1 Minutes.  
 Operating Temperature: -40°C~+85°C Humidity 80% R.H. Max.

Notes:  
 1. Material:  
 Housing: High Temperature Thermoplastic  
 Terminal: Copper Alloy  
 Shell: Stainless Steel  
 2. Plating:  
 Terminal: 50u" Ni Underplated Overall  
 G/F Plated on Contact Area  
 Matte Tin Plated on Solder Area  
 Shell: 30u" Ni Underplated Overall  
 3. Technical Speciality:  
 Rated Voltage: 30V  
 Current Rating: 0.5A  
 Insulation Resistance: 1000MΩ Min.  
 Contact Resistance: 100mΩ Max.  
 Withstanding Voltage: 500V DC For 1 Minutes.  
 Operating Temperature: -40°C~+85°C Humidity 80% R.H. Max.

CIRCUIT DIAGRAM FOR DETECT SWITCHES

CARD INSERTED	WITHOUT CARD

PIN/NO	ASSIGNMENT	MILLIMETERS	INCH
C1	VCC	X.° ±2°	X.° ±2°
C2	RST	X ±0.30	X ±0.012
C3	CLK	XX ±0.20	XX ±0.008
C5	GND	XXX ±0.10	XXX ±0.004
C6	VPP		
C7	I/O		
CD1	POL		
CD2	Detect Switch		

TITLE	SIM card 6+2PIN PUSH PUSH 卡座 外壳脚距5.25MM 无定位柱
PART NO.	XDSM-8011-0526
PRO J.	1/2
PAGE	1/2
SIZE	A4
SCALE	1:1
DWG NO.	102016502
APPD.	

**深圳市连欣科技有限公司**

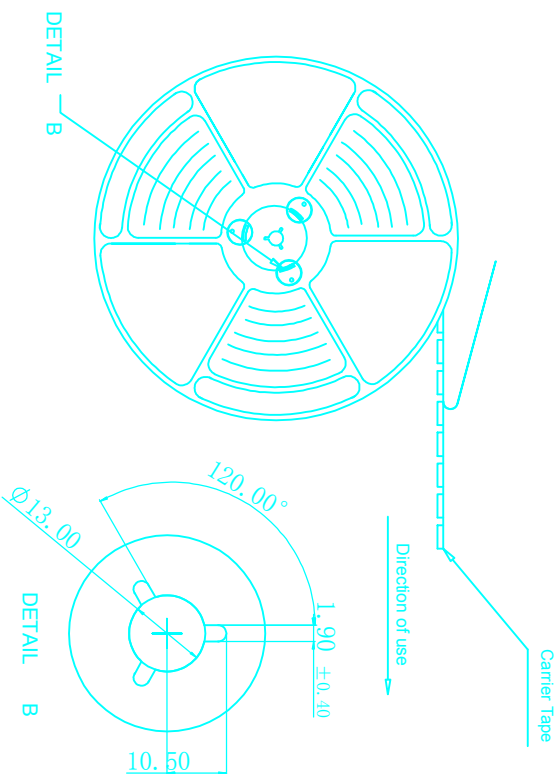
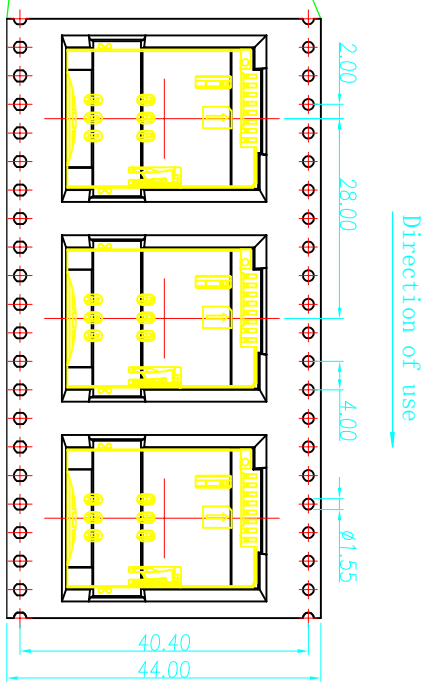

NOTES:

- 1、Packing quantity per plate: 550PCS/Plate
- 2、Loading and packing method

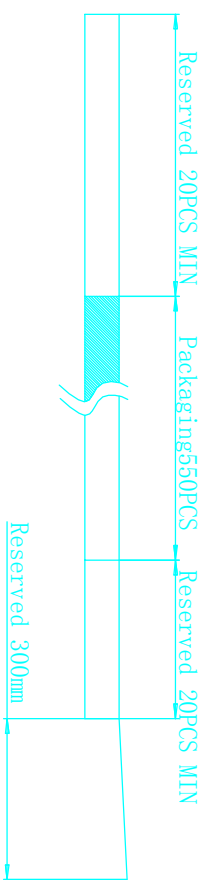

- 3、Total packaging: 3300PCS/Box

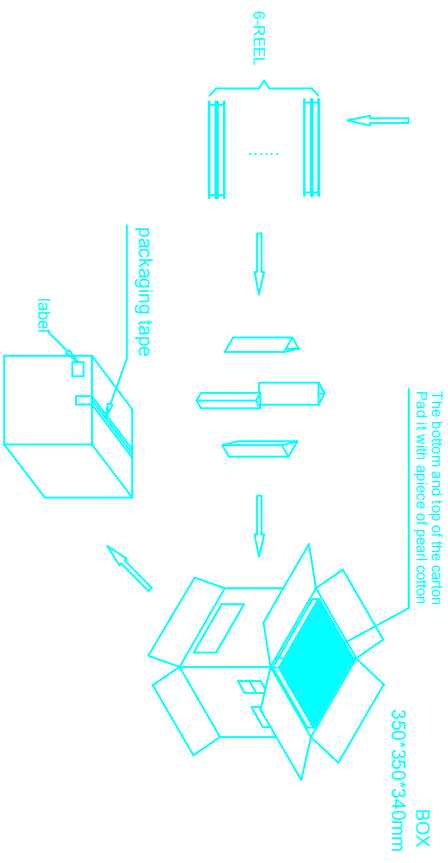

MILLIMETERS	INCH
X.° ±2°	X.° ±2°
X ±0.30	.X ±0.012
.XX ±0.20	.XX ±0.008
.XXX ±0.10	.XXX ±0.004

# 深圳市连欣科技有限公司

TITLE: SIM card 6+2PIN PUSH PUSH 卡座 外壳脚距5.25MM 无定位柱

PART NO.: XDSM-8011-0526 DWG NO: 102016502

PRO J.	PAGE	2/2	UNITS	mm	APPD
SIZE	A4	SCALE	1:1	DIS NO.	SM006-400<客户图>